

USER'S MANUAL HAKI COMPACT STAIR TOWER MK2

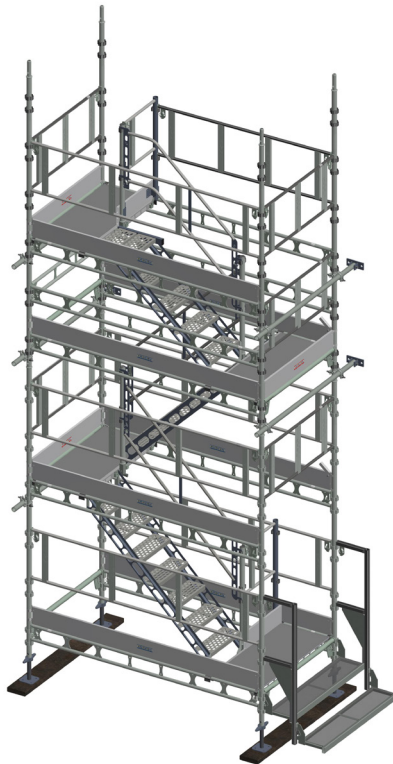

Important information

HAKI's product liability and user's manuals apply only to scaffolds that are entirely composed of components that have been made and supplied by HAKI.

HAKI's scaffold systems must not be erected using components of makes other than HAKI or be connected to scaffolds of makes other than HAKI. In such cases, a special study of load-bearing capacity must be carried out. However, HAKI has no objection to the customary addition of scaffold tubes and approved couplers to the scaffold.

Adding components from different suppliers may invalidate the insurance cover.

This user's manual is based on a minimum of 2 competent erectors wearing safety harnesses with twin tail lanyards.

This user's manual is to be used in conjunction with HAKI training courses.













HAKI reserves the right to make technical modifications on a continual basis.

The latest versions of HAKI user's manuals can be downloaded from our website, www.HAKI.com.

For scaffold structures that are not covered by this user's manual, please contact HAKI's technical department.

HAKI colour code

Horizontals and diagonals are marked with their nominal sizes (bay sizes) and a colour code. The marking is a useful means of identification when erecting and handling the scaffold material.

564		1050		1964		3050	
700		1250		2050			
770		1550		2500			
1010		1655		2550			

Forces and dimensions

1000 N = 1 kN ~ 100 kg

10 N ~ 1 kg

All measurements in mm

HAKI Compact Stair Tower MK2

All HAKI Systems have been designed to conform to current British and European Standards. The loading criteria contained in this manual have been calculated according to current European Standards, SS-EN 12810 and SS-EN 12811.

General

The Compact Stair Tower MK2 is made from pre-fabricated components for Light Duty applications. All components are hot-dip galvanized. The HAKI Compact Stair Tower MK2 consists of HAKI Universal base jacks, standards, beams, diagonal braces and guardrails.

Other components that are designed specifically for Compact Stair Tower MK2 include stair flights, landings, handrails, toeboards, etc.

Compact Stairs are erected with bay widths of 1250 mm, bay lengths of 2500 mm and with 1500 mm or 1000 mm between lifts. It can be erected both as a separate construction or integrated into other scaffolding or staging.







Marking

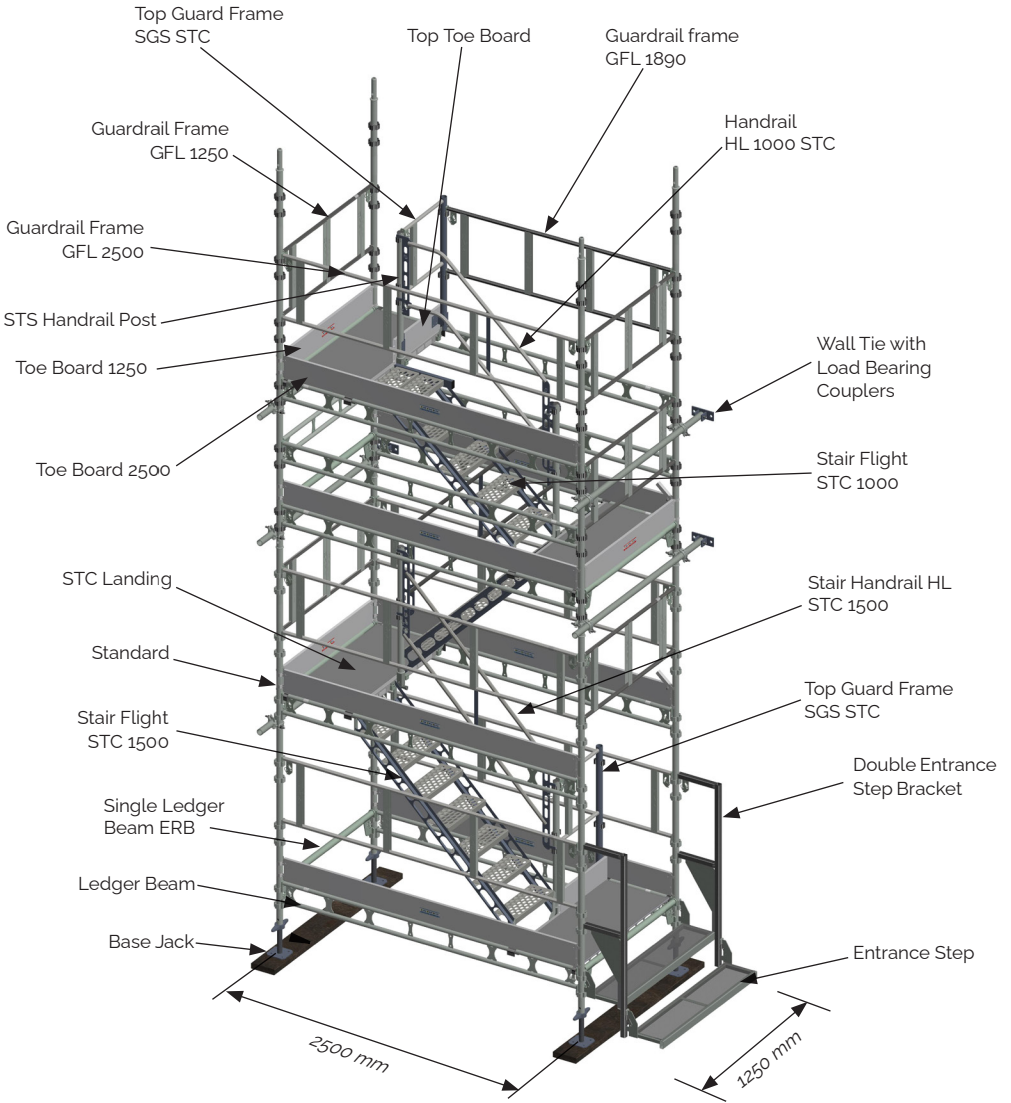



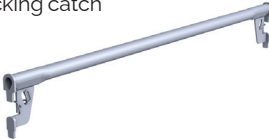

All components, with the exception of locking catches, pins etc, come permanently marked with the HAKI logo or HAKI text, the first letter of the country of manufacture and the last two figures of the year of manufacture (S24).



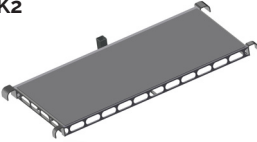

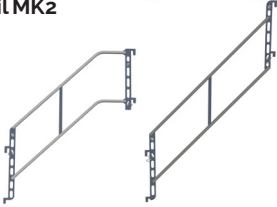

All load bearing components are marked for full traceability.

	 IMPORTANT! ENGAGE LOCKING CATCHES AS EACH COMPONENT IS FIXED	
--	--	---



Name		Code/Data	Item No.	Weight(kg)
Base Jack BS Adjustable 55-570 mm			2071000	5.0
Standard S Standard joint with spigot Pockets at same level Ø48 mm		500 1000 1500 2000 3000	7016050 7016100 7016150 7016200 7016300	2.9 5.3 7.7 10.1 15.2
Spring pin Ø 12 mm			2113100	0.2
Locking pin Steel Ø 16 mm For reinforcing standard joint in connection with tensile load, e.g. when scaffolding is suspended, lifted or when is used for temporary roof			5141257	0.3
Ledger beam LBL With spring locking catch Ø 34 mm		1250 1655 2500	7021122 7021162 7021252	6.5 6.7 10.9
Single Ledger ERB With spring locking catch Ø 48 mm		1250	7022121	5.1
Guardrail Frame GFL With spring locking catch		1250 1655 1890 2500	7052124 7052164 7052185 7052254	5.7 7.4 7.9 9.2

Name	Code/Data	Item No.	Weight(kg)
STC Landing MK2		7095005	15,0
			
STC Stair Flight MK2	1000 1500	7101115 7101202	20,0 23,0
			
STC Handrail MK2	1000 1500	7058110 7058154	7,1 7,3
			
STC Top Guard Frame MK2		7053007	6,4
			
STS Handrail Post Wedge Post locks with wedge	1000	7015104	4,6
			
STS Entrance step ITR	1250	7103120	11,1
			
STS Double Entrance step bracket		7103150	8,6
			

Name		Code/Data	Item No.	Weight(kg)
Toe board AL		1250	4161121	2.2
		1655	4161161	2.9
		2500	4161251	4.6
Top Toeboard		620	2026010	1.6
Diagonal Brace DS With wedge couplers Ø48 mm		DS 1250 L=2004	7122124	9.0
		DS 2500 L=2967	7121254	12.6
Other components				
Name		Code/Data	Item No.	Weight(kg)
Compact soldier board With coupler		970	2026040	3.0
Intermediate standard With nut N=21		S 2000 21	7015007	12.5
		S 1000 21	7015009	6.1
		S 1500 21	7015011	8.8
Puncheon Unit S For ledger beams With locking screw			7208018	3.9
Adjustable Castor Wheel Ø 38 mm Permissible load 10.0 kN, moving 4.0 kN			2012005	7.4

Name	Code/Data	Item No.	Weight(kg)
Wall tie VST	1000	7111100	5.3
With flexible plate Assembled with right angle coupler RA Ø48 mm x Ø48 mm	2000	7111200	9.1
	3000	7111300	13.7
	4000	7111400	16.7
	5000	7111500	21.9
	6000	7111600	24.5
Right Angle Coupler	RA 48x48 22	2048010	1.2
With nut N=22			



Erection accessories

Name	Code/Data	Item No.	Weight(kg)
HAKI Steel Deck	1250X230	21521250	7.6
Load class 6 (6,0 kN/m ²)			
Light Deck/Erection Platform AL	1250X600	4071128	9.1
Load class 3 (2kN/m ²)			
Double beam Rider		7208033	2.4
For guardrail frame or ledger beams			
With locking screw N=21			
Beam Rider BRS		7208020	2.0
For Tube diameter 34 mm			
With locking screw			
Advanced Guardrail Tool AGR AL		4052001	1.4

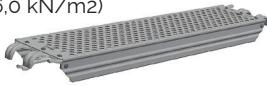

For other accessories, see HAKI Component List.

Information on safety when erecting and dismantling

1. Before erecting or dismantling a scaffold, the working area should be fenced off where possible.
2. The location for the scaffold must be checked in order to prevent risks when erecting, dismantling and moving the scaffold and to ensure that work can be carried out safely with regard to level and slope, obstacles and wind conditions.
3. Make sure that all lifting equipment to be used, e.g. chain hoists, lifting ropes, pulley blocks, etc., has been thoroughly tested and approved by an authorized person in accordance with local regulations.
4. Check that tools and protective equipment are available at the worksite.
5. Wear appropriate personal safety equipment at all times, e.g. safety harnesses, proper independent lifelines with suitable fixings, etc.
6. When erecting and dismantling a scaffold, robust temporary decking must be used as temporary platforms for the scaffolders.
7. Always make sure that the safety locking devices that prevent a platform lifting off have been activated once a platform has been installed.
8. Study all relevant instructions or safety directions from the manufacturers of the various scaffolds that are to be used.
9. Never climb up a scaffold from the outside. Always use the stairs, ladders or climbing frames that are designed to provide access to the upper decks from the inside of the scaffold.
10. If the scaffold is located outdoors, erection or dismantling work must be discontinued in severe weather conditions. All loose components and materials must be secured prior to leaving the scaffold.
11. All scaffolding work must be undertaken by competent operatives under the supervision of a competent person.
12. Raising and lowering of parts, material and tools using ropes or slings must be carried out in a protected lifting area.
13. Lifting equipment must not be fitted to scaffolding unless ties or equivalent devices are secure.
14. Beware of any overhead power lines nearby.
15. Always observe and comply with the regulations issued by the local authorities concerned.
16. Operatives should always be clipped to a single ledger or ledger beam during erection/dismantling. Reference should be made to the "Personal Safety Equipment" section in the HAKI Universal User manual.

Before erecting the tower, check and flatten out the ground. The ground must not be subject to uneven settlement. The ground's bearing capacity may be improved with the help of sole pads.



1. Lay out material to form base lift.

Position base jacks on sole pads, in approximate position of standards.

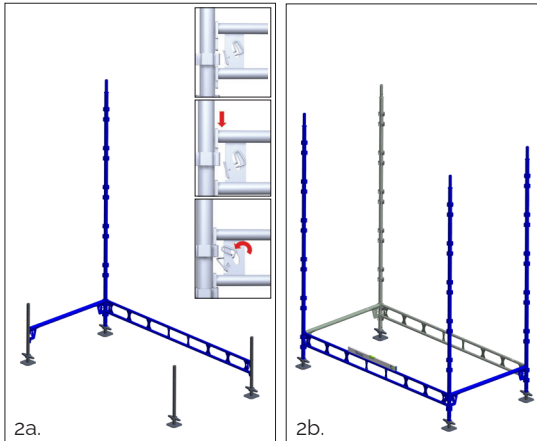

2a. Install the first standard and fit a 1250 single ledger and a 2500 ledger beam to it.

Ledgers must be fitted to the lowest group of pockets on all the standards. Lock the beams into position.

2b. Install remaining standards and ledgers in order to complete the first lift.

The standards must be one metre higher than the next lift.

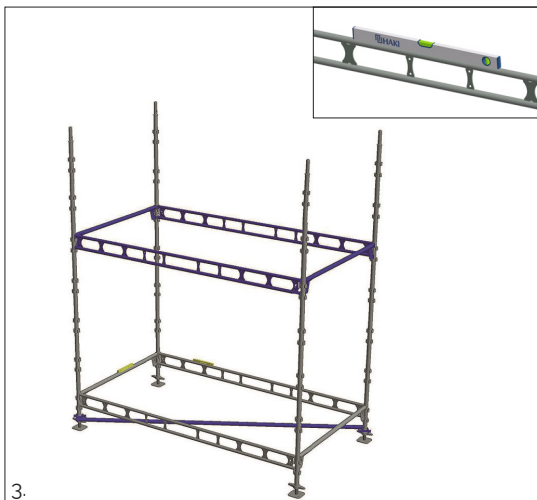

3. Install a second level of ledgers and single ledgers either 1 m or 1,5 m, depending on the stair configuration, above the first set of beams.

If necessary, install a temporary plan brace in order to ensure that the stair tower is square. Then check the levels in both the transverse and longitudinal directions using a spirit level and adjust using the base jacks.

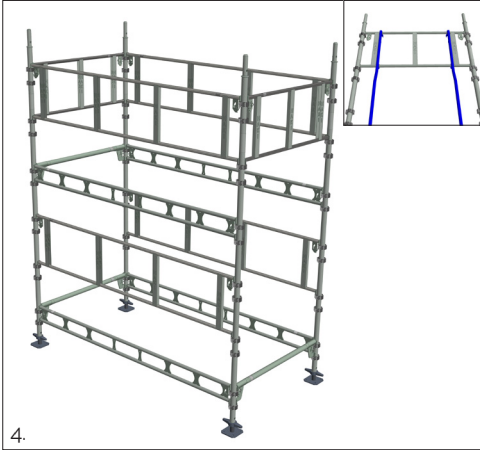

4. Install 2500 guardrail frames at the lowest level.

NOTE: A 2500 guardrail frame should always be fitted adjacent to a 1.5 m stair flight and a 2500 ledger beam fitted adjacent to a 1.0 m stair flight.

Install the second lift with guardrail frames in both the transverse and longitudinal direction using AGR tools.

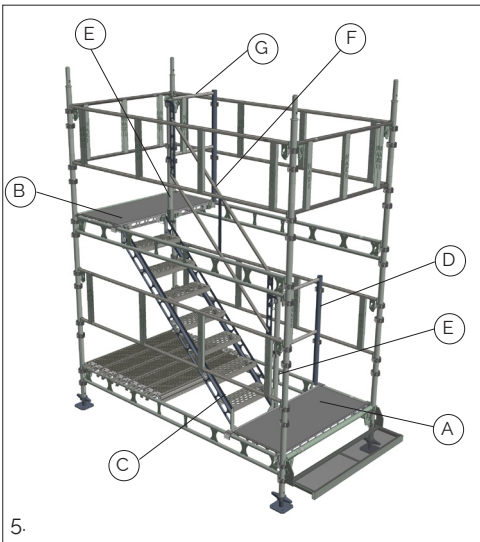

5. Install the first landing A so that the hooks rest on the ledger beams.

Hook on an entrance step for easy access to the lowest lift.

Stand on an erection platform or HAKI steel decks and install the second landing B.

Hook a stair flight C into the pockets of the landings.

Install a handrail posts with wedge E on both landings and Install a handrail F and lock it.

Install a top guard frame D on the lowest landing and from behind the handrail, install a top guard frame G on the second landing. Lock the chain of the top guard frames into position.

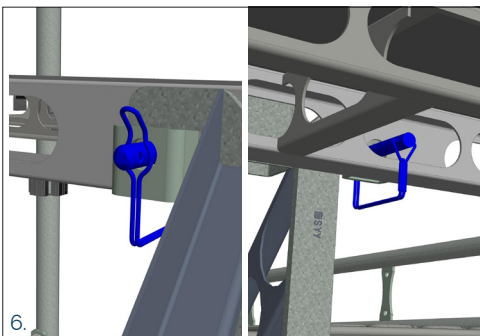

6. The stair flights should be locked in the landing using spring pins (2 per flight).

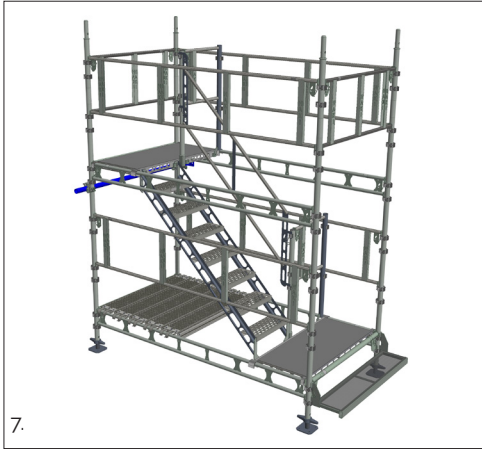

7. Install first tie under the landing at 2 m from the ground using tube with load bearing couplers through both standards.

NOTE: HAKI wall ties have a plate at one end. The plate can rotate horizontally and it is fixed to the wall with two anchoring screws. The tie assembly used must support the tie loads specified.

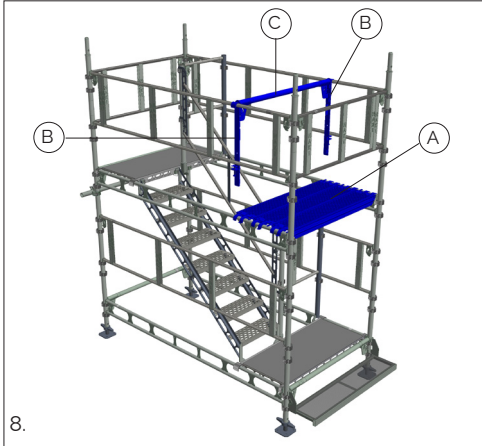

8. To create a safe zone, lift up the erection platforms A to the next level and install two double beam riders B on the guardrail frames and 1250 guardrail frame or 1250 single ledger C.

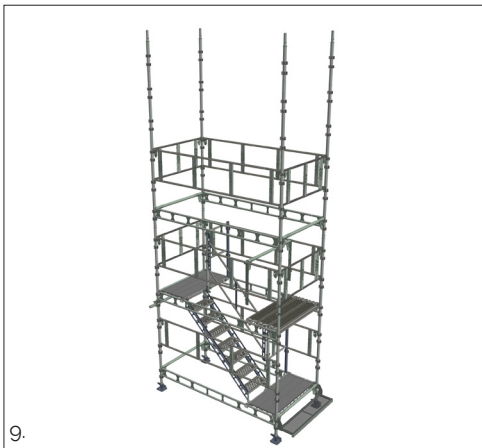

9. Install next set of standards, single ledgers and ledger beams for the third lift.

Install guardrail frames to next lift using AGR tools.

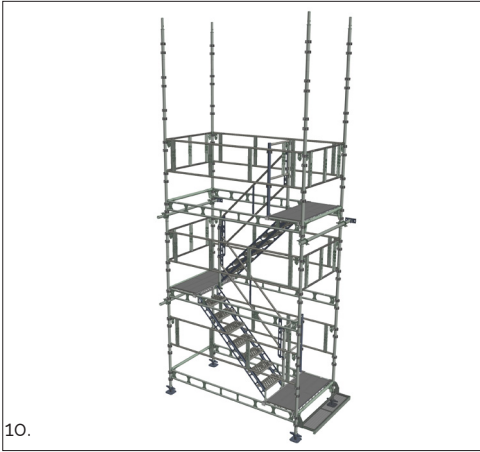

10. From the erection platforms, install the next landing. Remove the top guard frame. Install a stair flight, handrail post with wedge and handrail.

Install the top guard frame and ties.

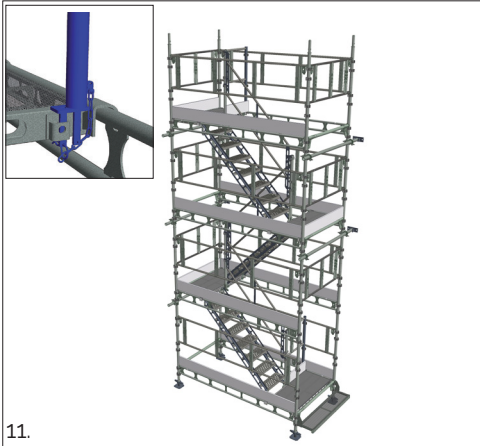

11. Continue erection up to the desired height as per steps 8, 9 and 10.

Once stairs are to required height secure all wedges for center posts and install all toeboards.

On the top lift, guardrail frames are installed in both the transverse and longitudinal directions as well as toeboards and a top guard frame with top toeboard. Lock the chain of the top guard frame into position.

Additional stair flights are carried up the stairs and 'rested' on erection platform.

Side exits

Top landing with side exit

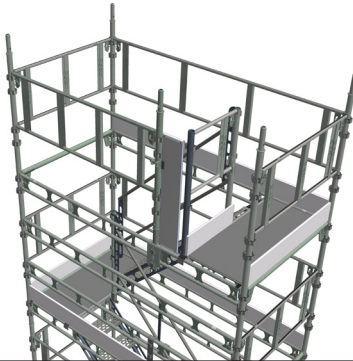

12a

12a. Install a 1655 guardrail frame on a 1000 standard with puncheon unit. Secure the standard and puncheon unit with a locking pin 16 mm.

Install a compact soldier board on the 1000 standard with puncheon unit and secure using the half coupler.

Intermediate side exit

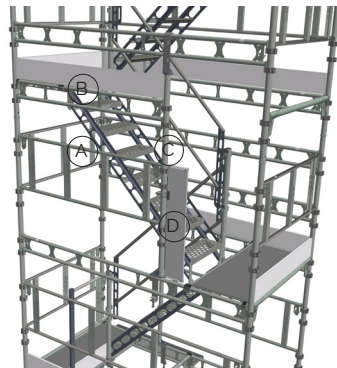

12b

12b. For an intermediate side exit next to a 1500 mm flight, install a 2000 intermediate standard C to a 2500 ledger beam 2 m above the required exit level.

Install 1655 guardrail frame A and 1655 ledger beam B onto Intermediate standard C.

Install a compact soldier board D on the intermediate standard C and secure with the half coupler.

NOTE: 1655 toeboard is required to be installed to landing above the side exit.

Bottom side exit

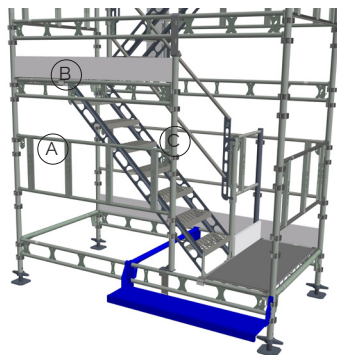

12c

12c. Install two double beam riders on the ledger beams and 1250 single ledger.

Hook on an entrance step for easy access to the lowest lift.

Install a 1655 guardrail frame A with respective 1655 ledger beam and 1655 toeboard B, on an intermediate standard C, as per an intermediate side exit.

Information on safety when dismantling

1. Do not throw or drop materials to the ground. This may damage the material or cause personal injury. The materials must be lowered down to the ground by means of ropes or slings or passed down by hand.
2. If intermediate ties or tie rod tubes have been installed, they must not be removed until the dismantling process reaches the level in question.
3. Always observe and comply with the regulations published by the local authorities concerned.
4. Operatives should always be clipped to a single ledger or ledger beam during dismantling.
5. Reference should also be made to section "Information on safety when erecting and dismantling" on page 9 in this manual.

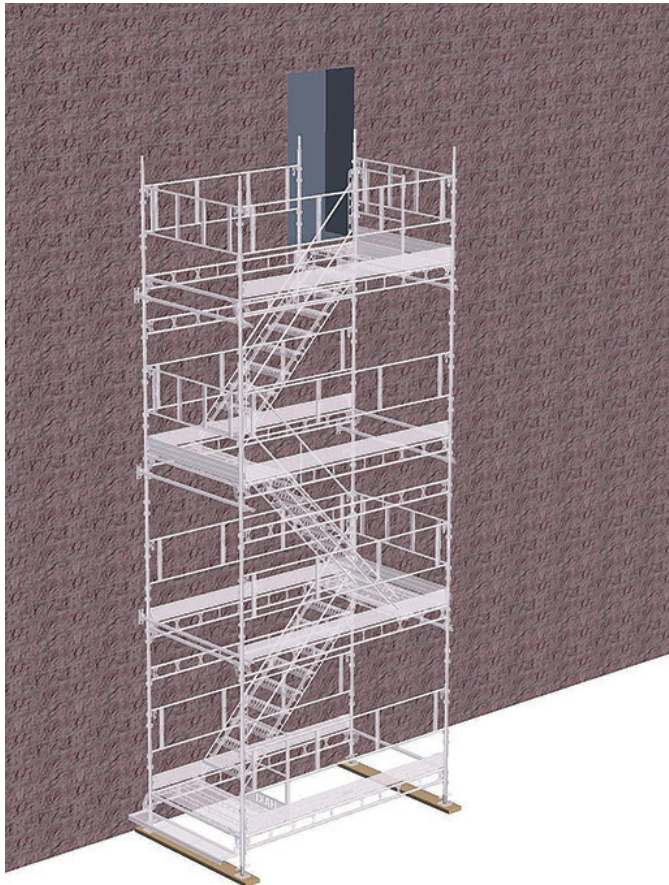

5 m HAKI Compact Stair Tower MK2

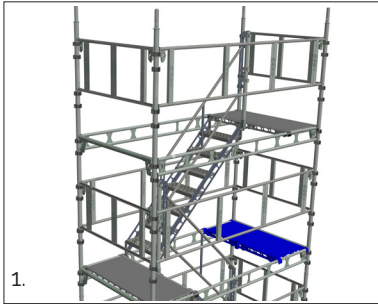

1. Remove all the toeboards.

From behind the handrail, remove the top guard frame with top toeboard and the guardrail frame.

Install the erection platform or HAKI steel decks below the top landing using AGR tools.

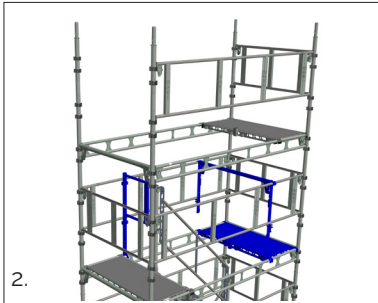

2. From the safe zone, remove the handrail and handrail post with wedge.

Remove the stair flight.

Re-install the top guard frame.

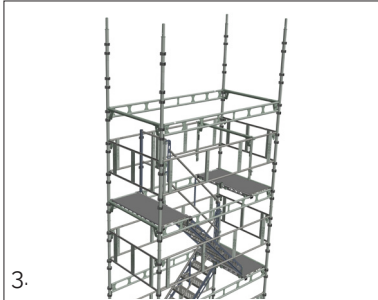

3. From the erection platforms remove the top landing.

Remove all the guardrail frames using AGR tools.

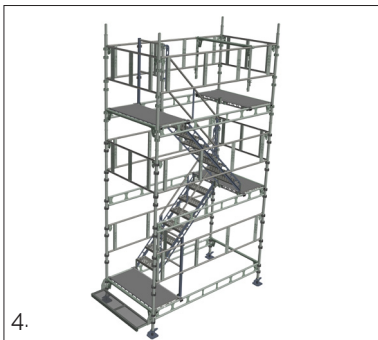

4. Remove the single ledgers, ledger beams and standards.

Repeat same dismantling procedure until dismantling is complete.

Bracing and tying in

The HAKI Compact Stair Tower MK2 should be anchored to the façade or equivalent at every lift level or alternate lift levels and the top landing level from both the inside and outside standard using scaffold tube and load bearing couplers.

NOTE: The tie assembly used must support the tie loads calculated. A competent person must check that the adjacent structure will support all the loads.

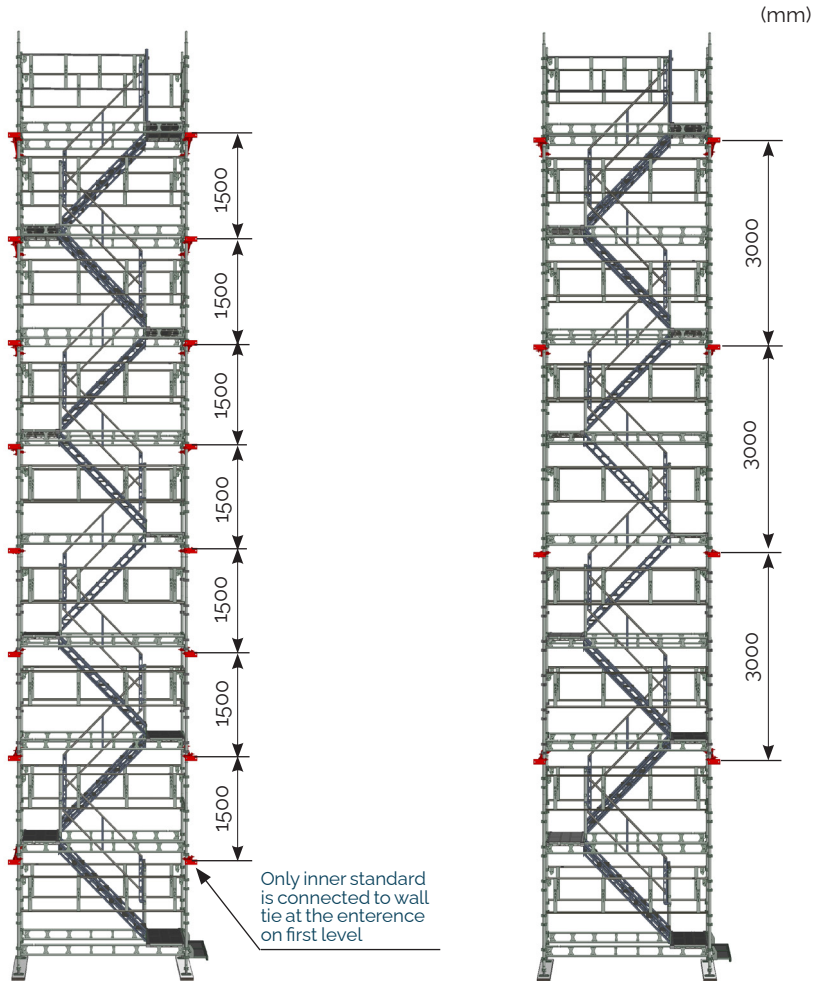

a) 1,5 m tie pattern

b) 3 m tie pattern

Base jacks

The HAKI Compact MK2 is erected on base jacks of type BS, which are adjustable between 55-570 mm.

If greater adjustment is needed, lower the base jacks and connect the beams to the next group of pockets. This means that it is always possible to adjust the standards so as to make the beams level.

Standards

Standards of length 3000 and 1500 mm are normally used in the compact stair tower.

Beams

The HAKI Compact MK2 is erected using 2500 ledger beams and 1250 single ledgers as ledger and transom beams respectively.

Guardrails

Stair flights must be provided with handrails on the inside. The compact stair tower must be provided with 2500 and 1250 guardrail frames at every half metre on the outside of the stair flight.

The compact MK2 should be provided with toeboards at all landings.

Permissible loads

The HAKI Compact MK2 is capable of supporting a minimum uniformly distributed load of 4kN/m² on all treads and landings. In addition to the uniformly distributed load, the stair treads and landings withstand a concentrate load of 1,5kN in the most unfavourable position.

Maximum Loading UDL over 10 m height	Wall tie spacing (m)	Permissible standard load (kN)	Max height (m) at 1 kN/m²	Max height (m) at 4 kN/m²
Base jack extension max 570 mm	1,5	30,6	108	82
	3	24,3	86	60
Base jack extension 300 mm	1,5	50	190	164
	3	29,7	102	76

Maximum Loading UDL over whole height	Wall tie spacing (m)	Permissible standard load (kN)	Max height (m) at 1 kN/m²	Max height (m) at 4 kN/m²
Base jack extension max 570 mm	1,5	30,6	61	26
	3	24,3	48	20
Base jack extension 300 mm	1,5	50	99	43
	3	29,7	59	25

For other loads, please contact HAKI's technical department.

Methods of erection when guardrail frame is fitted in advance

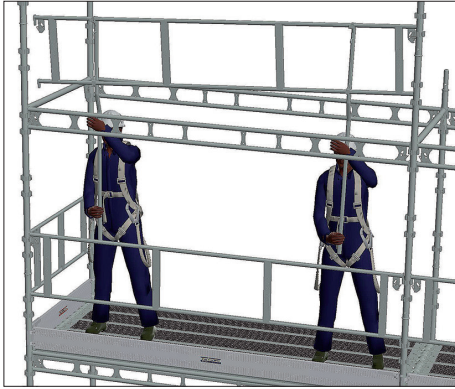

Use HAKI's advanced guardrail tool (or the aid of other guardrail fitting devices) to fit guardrail frames prior to the stair flight installation.

The standards must be one metre higher than the next lift. Some alternative methods of erection to achieve this are shown in the pictures below.

For other fitting devices, see HAKI Component List.

HAKI Safety Checklist

Stability

- Height & use of tower is within manufacturers recommendation's (If not alternative design in place & available)
- Ties (Correct number & Installation)
- Kettlehead
- Sole pads
- Base plates/Base Jacks
- Surrounding ground conditions

General tower

- Standards vertical within tolerances
- Ledgers & transoms level within tolerances
- Guardrail frames installed throughout
- Scaffold aligned correctly horizontally and vertically i.e. bracing correctly fitted
- All locking pins/catches engaged
- Are standards pinned (If required i.e. structure to be crane lifted, temporary roof added creating uplift, cantilevers added above last tie point, etc)

Flights & Landings

- All flights in good condition:
 - Visual check for straightness, check complete treads for dents
 - Check all hooks are straight
 - Check all welds for any cracks or deterioration
- All flights sitting correctly on landings
- All flights installed correctly & secured with spring pins 12mm
- All landings toe boarded

Exits

- All exits clear & unobstructed
- Acceptable height on Entrance step (If not, recommended action i.e. install double step brackets & additional step or make up entrance step with alternative materials.
- All exits guard railed off on to access platform/ into structure

Other

- Cladding/sheeting to tower's condition

Notes

Notes



Experience

With over 60 years experience to call on, HAKI has gained a leading reputation in its field. With its own R & D and manufacturing facilities, the company now operates throughout Europe and its equipment is in use worldwide. With all products designed and manufactured to ISO 9001:2015, and a comprehensive training and support infrastructure, you can rely on HAKI for support.



Training

The Company's dedicated Training Centre is equipped with the full range of HAKI products where a comprehensive choice of courses is offered. With the benefit of this training, all users of HAKI products can be assured that the equipment is being employed safely and effectively.



Support

From computerised estimating facilities to on site assessment and project back up, HAKI is with its customers every step of the way. Working with HAKI means far more than just proven equipment, it means working with people who understand the scaffolding industry. Whatever the project, the company is committed to ensuring every user enjoys the full benefits associated with the use of HAKI - maximising the savings, profitability, and above all, SAFETY.

Health and Safety at Work Act, 1974

HAKI equipment is designed to meet the requirements of the above Act, Section 6.

It is also the customer's responsibility to comply with the requirements of this Act, particularly to use the equipment in accordance with current codes of practice and in ensuring that components are in good working condition prior to each use.

We are able to provide assistance and advice on matters relating to safe and proper use of HAKI equipment.

